

10-frame beehive AS

(Api Standart)

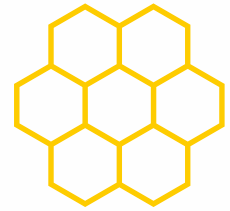

BioIn



- ◆ The AS beehive (Api Standard) is a new generation of beehive that combines the best of various technologies and avoids the shortcomings of standard wooden hives or newer polystyrene hives.
- ◆ Each element of the hive is designed and constructed by the most suitable materials for its function.
- ◆ The hive is built on the basis of many years of experience of beekeepers, and we would like to express our gratitude for the cooperation of Nikolay Gaydov.



Deep bottom

The bottom of the hive is made of 3 concrete elements and a removable drawer made of plastic suitable for food purposes.

The removable drawer opens from the back of the hive.

It has the following elements:

Bottom feeder for liquid food with a capacity of 5 litres.

Removable pollen collector with a 1.4 liter pollen container.

Cover over the pollen collector to prevent pollutants from entering bee pollen. Stainless steel mesh ventilation aperture with dimensions 18 x 15 cm.

The entrance to the hive has a combined mouse fuse consisting of 2 elements with the following functions:

In the period in which pollen is collected, element 1 is placed in position 1, and through element 2 the two left or the two right bumblebees entrances can be blocked from time to time.

During winter, element 1 is turned to position 2, and through element 2 from 0 to 7 entrances for exiting of bees from the hive may remain open.

Main advantages:

No other elements are required for installation on the ground (concrete piles, curbs, etc.)

The bottom of the hive does not rot and no painting is required.

Rapid filling of bottom feeder with liquid food.

Easy operation, allowing fast handling of a large number of hives.

Easy to clean.

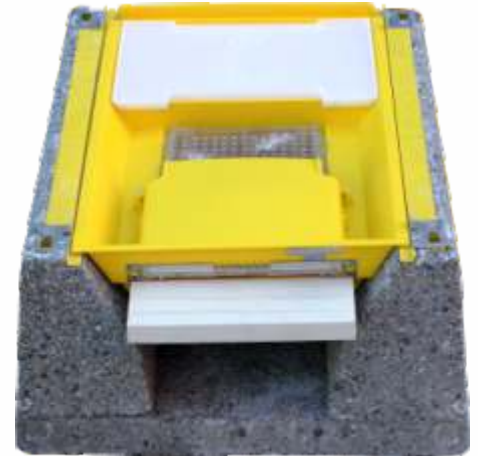

Item No. 1001 - 25.00 EUR

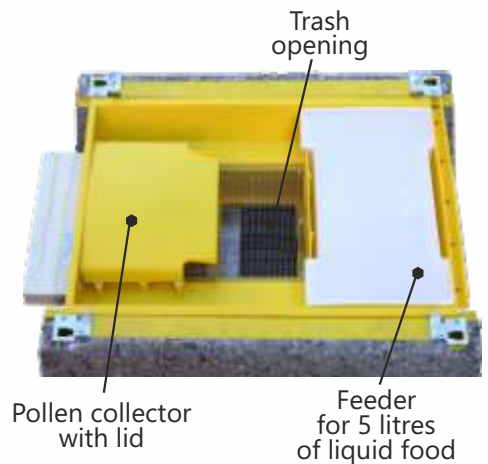

Opens up as a drawer at the rear

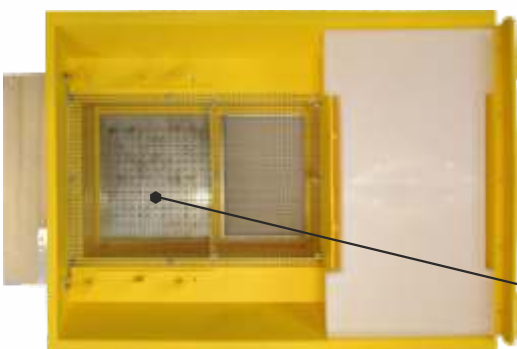

Pollen tank





BioIn



Plovdiv
242 "Vasil Levski" Str
+359 888 74 74 80
office@bioin-bg.com
Био иновации

Protection system

AS (Api Standard) is the only beehive designed with a protection system.

The purpose of the system is to reduce the risk and to eliminate theft in practice. The protection is realized as follows: there are 4 metal inserts built-in the concrete foundation of the hive.

The upper feeder with the storehouses locks to the foundation by means of 4 threaded rods passing through the aluminum corners of the storehouses, and the top cover locks to the upper feeder.

The locks need to be broken for the hive to be stolen. In case there are such power interventions, bees become aggressive enough to act as an additional protection.

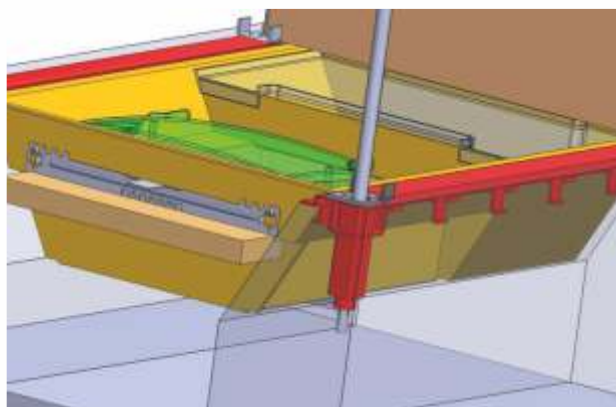

Item No. 1002 - 7.00 EUR



Body

The AS beehive bodies (Api Standard)

are made of 2.5 cm thick wood, with 4 aluminum profiles for edge fastening and 2 additional metal inserts on a storehouse for easier detachment of body from body.

Main advantages:

Upon defect, individual sections may be replaced.
Metal inserts, for easier detachment upon gumming.

Internal dimensions:

- 376 x 450 x 170 mm

- Painted Item No. 1020 - 22.00 EUR
- Unpainted Item No. 1010 - 12.00 EUR

- 376 x 450 x 240 mm

- Painted Item No. 1030 - 26.00 EUR
- Unpainted Item No. 1011 - 15.00 EUR

- 376 x 450 x 310 mm

- Painted Item No. 1040 - 32.00 EUR
- Unpainted Item No. 1012 - 17.00 EUR





BioIn



Plovdiv
242 "Vasil Levski" Str
+359 888 74 74 80
office@bioin-bg.com
Био иновации

Upper feeder

Material:

polypropylene for food purposes.

The feeder has three compartments.

Two of the compartments has 1.6 litres capacity, suitable for solid or liquid food.

In the middle there is a third compartment with a stainless steel mesh over which you may put 2.5 litres of paste-like food.

Above the net there is a moisture storage tray with two possible positions.

Item No. 1050 - 7.00 EUR



Top cover

Material:

polypropylene for food purposes,
aluminium and 2 cm Styrofoam.

Weight: 1.8 kg

Item No. 1060 - 11.00 EUR





Frames for sale of comb honey

4 sectional standard storehouse Dadant Blatt frame

Material:
 polypropylene for food purposes

Total Frame Size::
 440 x 160 mm
 Item No. 1070 - 0.75 EUR

Components:
 section 160 x 105 mm
 Item No. 1071 - 0.10 EUR

set of connecting elements
 Item No. 1072 - 0.35 EUR

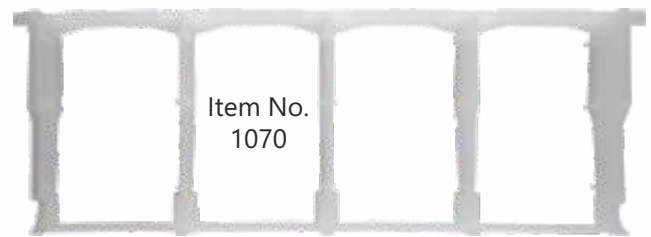

Item No. 1071

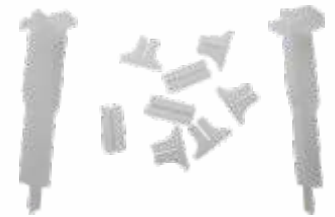

Item No. 1072

8 sectional standard storehouse Dadant Blatt frame

Material:
 polypropylene for food purposes

Total Frame Size:
 440 x 160 mm
 Item No. 1080 - 0.95 EUR

Components:
 section 80 x 105 mm
 Item No. 1081 - 0.075 EUR

set of connecting elements
 Item No. 10720.35 EUR

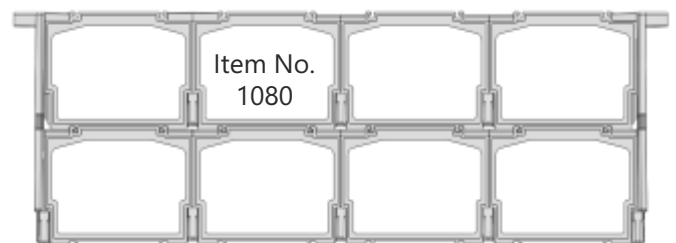

Item No.1081

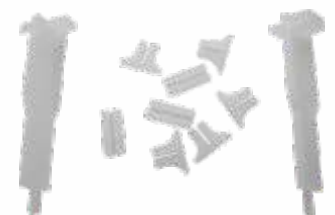

Item No.1072

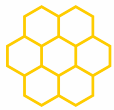

BioIn



Plovdiv
242 "Vasil Levski" Str
+359 888 74 74 80
office@bioin-bg.com
Био иновации

Packages for selling comb honey

for 1 section
of 4 sectional frame
Item No. 1074 - 0.40 EUR

for 1 section
of 8 sectional frame
Item No. 1088 - 0.30 EUR



Item No. 1074



Item No. 1088

Wasp Trap

Material:
Glass-filled polyamide

Designed for bottle cap.

1 pcs. - Item No. 1090 - 0.50 EUR

set of 2 pcs. - Item No. 1092 - 1.00 EUR

set of 5 pcs. - Item No. 1095 - 2.50 EUR



Uncapping Knife

Material:
polypropylene for food
purposes, stainless steel.

Directions for use
may be found at the following link:
<https://www.youtube.com/watch?v=QGHkqkaigRM&feature=share>

Item No. 1100 - 3.00 EUR



Prices can be changed.

BioIn